

# *CRUX*

***USER MANUAL***  
***ENGLISH***





## CONTENTS

<b>1. INTRODUCTION</b> .....	<b>1</b>
1.1. INTENDED USE .....	1
1.2. WARRANTY .....	1
<b>2. GENERAL NOTES ABOUT ASSEMBLY</b> .....	<b>2</b>
2.1. TOOLS / TORQUE SPECS .....	3
<b>3. GENERAL NOTES ABOUT MAINTENANCE</b> .....	<b>3</b>
<b>4. SPECIFICATIONS</b> .....	<b>4</b>
4.1. GEOMETRY .....	4
4.2. SMALL PARTS SPECIFICATIONS .....	6
<b>5. BRAKE/SHIFT ASSEMBLY</b> .....	<b>7</b>
5.1. SHIFTING - ELECTRONIC WIRED SYSTEM .....	7
5.2. SHIFTING - MECHANICAL SYSTEM (REAR DERAILLEUR ONLY) .....	10
5.3. DISC BRAKES .....	12
<b>6. SEATPOST ASSEMBLY</b> .....	<b>12</b>
<b>7. FORK / STEM ASSEMBLY</b> .....	<b>15</b>

### SPECIALIZED BICYCLE COMPONENTS

15130 Concord Circle, Morgan Hill, CA 95037 (408) 779-6229  
0000164405\_UM\_R3\_03/21

We may occasionally issue updates and addendums to this document. Please periodically check [www.specialized.com](http://www.specialized.com) or contact Rider Care to make sure you have the latest information.

Info: [specialized.com](http://specialized.com) / 877-808-8154

## 1. INTRODUCTION

This user manual is specific to your Specialized CruX bicycle. It contains important safety, performance, and technical information, which you should read before your first ride and keep for reference. You should also read the entire Specialized Bicycle Owner's Manual ("Owner's Manual"), because it has additional important general information and instructions which you should follow. If you do not have a copy of the Owner's Manual, you can download it at no cost at [www.specialized.com](http://www.specialized.com), or obtain it from your nearest Authorized Specialized Retailer or Specialized Rider Care.

Additional safety, performance and service information for specific components such as seatpost or pedals on your bicycle, or for accessories such as helmets or lights, may also be available. Make sure that your Authorized Specialized Retailer has given you all the manufacturers' literature that was included with your bicycle or accessories. If there is a difference between the instructions in this manual and the information provided by the component manufacturer, please refer to your Authorized Specialized Retailer.

When reading this user manual, you will note various important symbols and warnings, which are explained below:



**WARNING!** The combination of this symbol and word indicates a potentially hazardous situation which, if not avoided, could result in serious injury or death. Many of the Warnings say, "you may lose control and fall." Because any fall can result in serious injury or even death, we do not always repeat the warning of possible injury or death.



**CAUTION:** The combination of the safety alert symbol and the word CAUTION indicates a potentially hazardous situation, which, if not avoided, may result in minor or moderate injury, or is an alert against unsafe practices.

The word CAUTION used without the safety alert symbol indicates a situation which, if not avoided, could result in serious damage to the bicycle or the voiding of your warranty.



**INFO:** This symbol alerts the reader to information which is particularly important.



**GREASE:** This symbol means that high quality grease should be applied as illustrated.



**CARBON FRICTION PASTE:** This symbol means that carbon friction paste should be applied as illustrated to increase friction.



**TECH TIP:** Tech Tips are useful tips and tricks regarding installation and use.

### 1.1. INTENDED USE

The Specialized CruX bicycles are intended and tested for General Purpose Riding use only (condition 2). For more information on intended use and structural weight limits for the frame and components, please refer to the Owner's Manual.

### 1.2. WARRANTY

Please refer to the written warranty provisions provided with your bicycle or visit [www.specialized.com](http://www.specialized.com). A copy is also available at your Authorized Specialized Retailer.

## 2. GENERAL NOTES ABOUT ASSEMBLY

This manual is not intended as a comprehensive assembly, use, service, repair or maintenance guide. Please see your Authorized Specialized Retailer for all service, repairs, or maintenance. Your Authorized Specialized Retailer may also be able to refer you to classes, clinics, or books on bicycle use, service, repair, and maintenance.

- Tire sizes vary significantly from brand to brand. CEN standards require a minimum of 6 mm of clearance between the frame/fork and the tires. When choosing a wheel and tire combo, factor in enough clearance for the conditions, setup and wheel flex.
- The CruX frames use a 68 mm standard BSA threaded design. Grease the threads. Install and torque according to the bottom bracket manufacturer's instructions.
- Before installing the bottom bracket and crank, make sure all housings and wires are routed through the frame.



In order to successfully build the CruX bicycle, it is very important to follow the order of operations as outlined in this manual. Modifying the order of assembly will result in a longer build process.



Assembly of the front end of the bicycle is easiest with the rider's fit already determined (the steerer tube doesn't need to be cut at this time, it can stick out the top of the stem), prior to routing all the housings and wires through the frame and fork.

To determine fit, it is recommended to use a fit tool. If this is not possible, perform a basic assembly of the wheels, drivetrain and front-end components, without the brakes and housings. Once the fit is complete, all the components will have to be removed in order to route the housings and wires.



**WARNING!** Due to the high degree of complexity of the CruX, proper assembly requires a high degree of mechanical expertise, skill, training and specialty tools. Therefore, it is essential that the assembly, maintenance and troubleshooting be performed by an Authorized Specialized Retailer.



**CAUTION:** Do not face the bottom bracket shell! This can prevent proper installation of the crank. Your Specialized frame does not require any bottom bracket shell pre-installation preparation, as all surfaces have been precisely machined to specific tolerances at the factory for proper interface with a compatible crankset. Please refer to the manufacturer instructions for crank and bottom bracket installation.



**CAUTION:** Always use a bottom bracket equipped with a sleeve between the two cups. Running a bottom bracket without the sleeve can result in housings and/or wires contacting the bottom bracket spindle, which can result in wear.

## 2.1. TOOLS / TORQUE SPECS



**WARNING!** Correct tightening force on fasteners (nuts, bolts, screws) on your bicycle is important for your safety. If too little force is applied, the fastener may not hold securely. If too much force is applied, the fastener can strip threads, stretch, deform or break. Either way, incorrect tightening force can result in component failure, which can cause you to lose control and fall.

Where indicated, ensure that each bolt is torqued to specification. After your first ride, and consistently thereafter, recheck the tightness of each bolt to ensure secure attachment of the components.



**CAUTION:** Ensure that all contact surfaces are clean and bolt threads are greased or have a threadlocker compound (refer to the instructions for each bolt) prior to installation.

The following tools are required for installation of this product:

- 2, 2.5, 3, 4, 5, 6 mm socket-style Allen key bits
- Torque wrench
- High-quality grease
- Cable housing cutters
- Carbon assembly compound (fiber paste)
- Blue threadlocker

## 3. GENERAL NOTES ABOUT MAINTENANCE

The CruX is a high performance bicycle. All regular maintenance, troubleshooting, repair, and parts replacement must be performed by an Authorized Specialized Retailer. For general information regarding maintenance of your bicycle, please refer to the Owner's Manual. In addition, routinely perform a mechanical safety check before each ride, as described in the Owner's Manual.

- Great care should be taken to not damage carbon fiber or composite material. Any damage may result in a loss of structural integrity, which may result in a catastrophic failure. This damage may or may not be visible in inspection. Before each ride, and after any crash,

you should carefully inspect your bicycle for any fraying, gouging, scratches through the paint, chipping, bending, or any other signs of damage. Do not ride if your bicycle shows any of these signs. After any crash, and before you ride any further, take your bicycle to an Authorized Specialized Retailer for a complete inspection.

- While riding, listen for any creaks, as a creak can be a sign of a problem with one or more components. Periodically examine all surfaces in bright sunlight to check for any small hairline cracks or fatigue at stress points, such as welds, seams, holes, and points of contact with other parts. If you hear any creaks, see signs of excessive wear, discover any cracks, no matter how small, or any damage to the bicycle, immediately stop riding the bicycle and have it inspected by your Authorized Specialized Retailer.
- Lifespan and the type and frequency of maintenance depends on many factors, such as use, rider weight, riding conditions and/or impacts.
- Exposure to harsh elements, especially salty air (such as riding near the ocean or in the winter), can result in galvanic corrosion of components such as the crank spindle and bolts, which can accelerate wear and shorten the lifespan. Dirt can also accelerate wear of surfaces and bearings. The surfaces of the bicycle should be cleaned before each ride. The bicycle should also be maintained regularly by an Authorized Specialized Retailer, which means it should be cleaned, lubricated, and (partially) disassembled and inspected for signs of corrosion and/or cracks. If you notice any signs of corrosion or cracking on the frame or any component, the affected item must be replaced.
- Regularly clean and lubricate the drivetrain according to the drivetrain manufacturer's instructions.
- Do **not** use a high pressure water spray directly on the bearings. Even water from a garden hose can penetrate bearing seals and crank interfaces, which can result in increased bearing and crank wear, which can affect the normal function of the bearings. Use a clean, damp cloth and bicycle cleaning agents for cleaning.
- Do **not** expose the bicycle to prolonged direct sunlight or excessive heat, such as inside a car parked in the sun or near a heat source such as a radiator.



**WARNING!** Failure to follow the instructions in this section may result in damage to the components on your bicycle and will void your warranty, but, most importantly, may result in serious personal injury or death. If your bicycle exhibits any signs of damage, do not use it and immediately bring it to your Authorized Specialized Retailer for inspection.

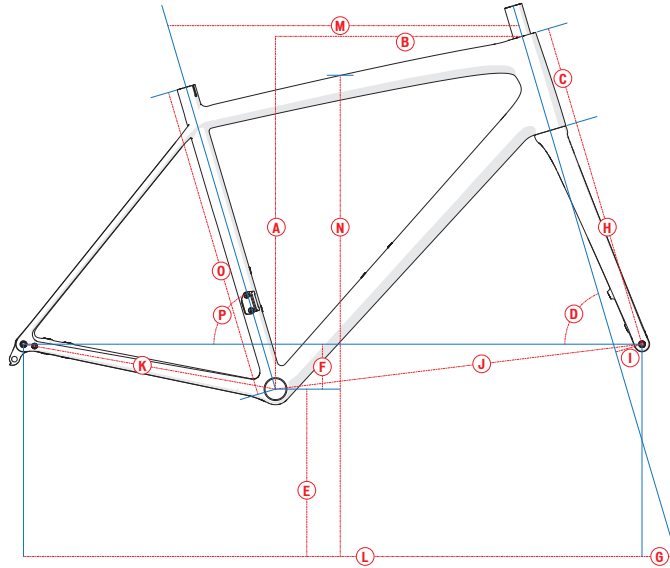

## 4. SPECIFICATIONS

### 4.1. GEOMETRY

	FRAME SIZE	49	52	54	56	58	61
A	STACK (MM)	530	547	560	578	598	621
B	REACH (MM)	375	382	388	397	405	415
C	HEAD TUBE LENGTH (MM)	100	115	130	147	167	190
D	HEAD TUBE ANGLE (°)	70.5	71.3	71.5	72	72.3	72.5
E	BB HEIGHT (MM)	284		286			
F	BB DROP (MM)	74		72			
G	TRAIL (MM)	74	69	67	64	62	60
H	FORK LENGTH, FULL (MM)	401					
I	FORK RAKE/OFFSET (MM)	50					
J	FRONT CENTER (MM)	594	600	608	618	630	644
K	CHAINSTAY LENGTH (MM)	425					
L	WHEELBASE (MM)	1008	1014	1023	1033	1045	1059
M	TOP TUBE LENGTH, HORIZONTAL (MM)	512	539	549	568	582	599
N	BIKE STANDOVER HEIGHT (MM)	749	772	794	816	841	866
O	SEAT TUBE LENGTH (MM)	466	496	521	546	576	606
P	SEAT TUBE ANGLE (°)	75.5	74		73.5		

## 4.2 SMALL PARTS SPECIFICATIONS

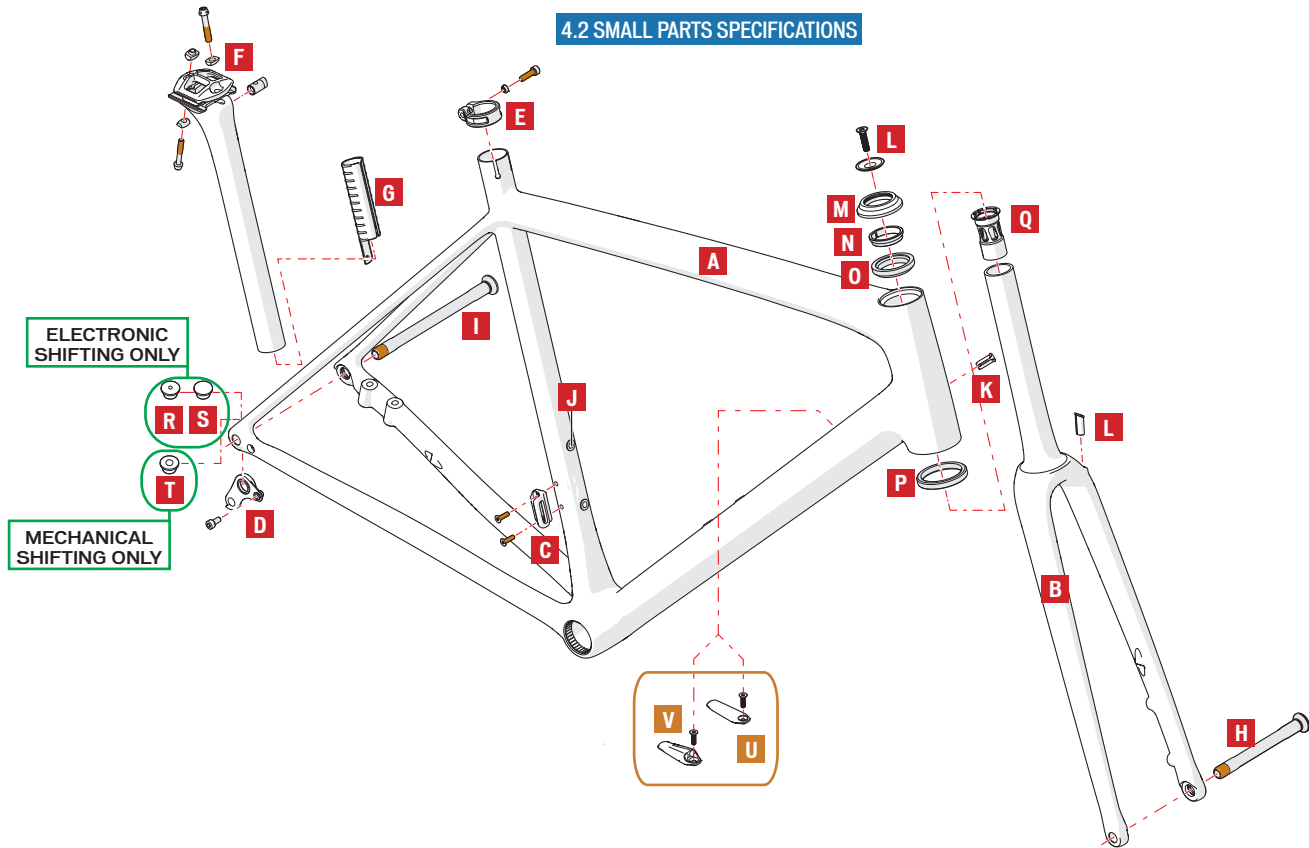



## 4.2. SMALL PARTS SPECIFICATIONS

All CruX models are compatible with electronic shifting (wired or wireless), and are compatible with 1x mechanical configurations.

	PART #	DESCRIPTION	TOOL SIZE	in-lbf	Nm
A		FRAME			
B	S212300017	FORK			
C	S201900005	*FRONT DERAILLEUR (FD) HANGER	2.5 MM	18	2.0
D	S182600001	REAR DERAILLEUR (RD) HANGER	4 MM	40	4.5
E	S174700006	SEAT COLLAR TI BOLT	4 MM	55	6.2
	S174700005	SEAT CLAMP STEEL BOLT	4 MM	55	6.2
F	S204900004	SEATPOST (FRONT RAIL CLAMP BOLT)	4 MM	26.5	3.0
		SEATPOST (REAR RAIL CLAMP BOLT)	5 MM	55	6.2
G	S186800006	DI2 BATTERY SLEEVE			
H	S200200010	FRONT AXLE	6 MM	133	15.0
I	S200200011	REAR AXLE	6 MM	133	15.0
J	S220500004	WATER BOTTLE	3 MM	25	2.8
K	S179900013	CABLE HOUSING FERRULE			
L	S202500013	STEM TOP CAP	4 MM		
M	S212500024	HEADSET COVER			
N		S192500005	COMPRESSION RING		
O		S092500002	UPPER HEADSET BEARING		
P		S162500005	LOWER HEADSET BEARING		
Q	S202500011	EXPANDER PLUG	6 MM	55	5.1
R	S159900006	REAR DERAILLEUR PLUG (WIRED)			
S	S179900015	REAR DERAILLEUR PLUG (WIRELESS)			
T	S226500002	REAR DERAILLEUR PLUG			

U	S186500003	DOWN TUBE ICR COVER PLATE	2.5 MM	7	0.8
V	S216500009	DOWN TUBE ICR MECHANICAL PORT	2.5 MM	7	0.8



Many bolts have a blue threadlock patch on the threads to help secure the bolt under torque. Repeated installation and removal of a bolt may reduce the effectiveness of the patch. However, it can be replaced with the application of a liquid blue threadlocker.

## 5. BRAKE/SHIFT ASSEMBLY

### 5.1. SHIFTING - ELECTRONIC WIRED SYSTEM

#### FRAME WIRING LENGTHS

LOCATION	QTY	LENGTH
JCT B BOX TO COCKPIT (SHIFTER)	1	1400 MM
JCT B BOX TO REAR DERAILLEUR	1	750 MM
JCT B BOX TO FRONT DERAILLEUR	1	500 MM
JCT A BOX TO BATTERY (SEATPOST)	1	1000 MM

FIG. 1 (Shimano Di2)

- Route a 1400 mm wire from the head tube ICR port, down the down tube and out the bottom bracket hole.



The Di2 wire must be routed into the down tube before the rear brake housing.

- Route a 750 mm wire starting from the chainstay port and out the bottom bracket hole.
- Route a 500 mm wire starting from the seat tube front derailleur port and out the bottom bracket hole.



To insert the front derailleur wire, follow the steps in section 5.

- Route a 1000 mm wire down from the top of the seat tube and out the bottom bracket hole.
- Install the grommets and clips on the battery, then install the battery/grommet assembly in the seatpost.
- Plug the 1000 mm battery wire into the battery, then install the seatpost as described in section 6.
- Plug the four wires exiting the bottom bracket shell into a Junction B box, then place the Junction B box and the wires in front of the bottom bracket shell.



To prevent the JCT B box from rattling, wrap the box in a bit of foam before placing it in front of the bottom bracket shell.

1

5.1 ELECTRONIC WIRED SYSTEM

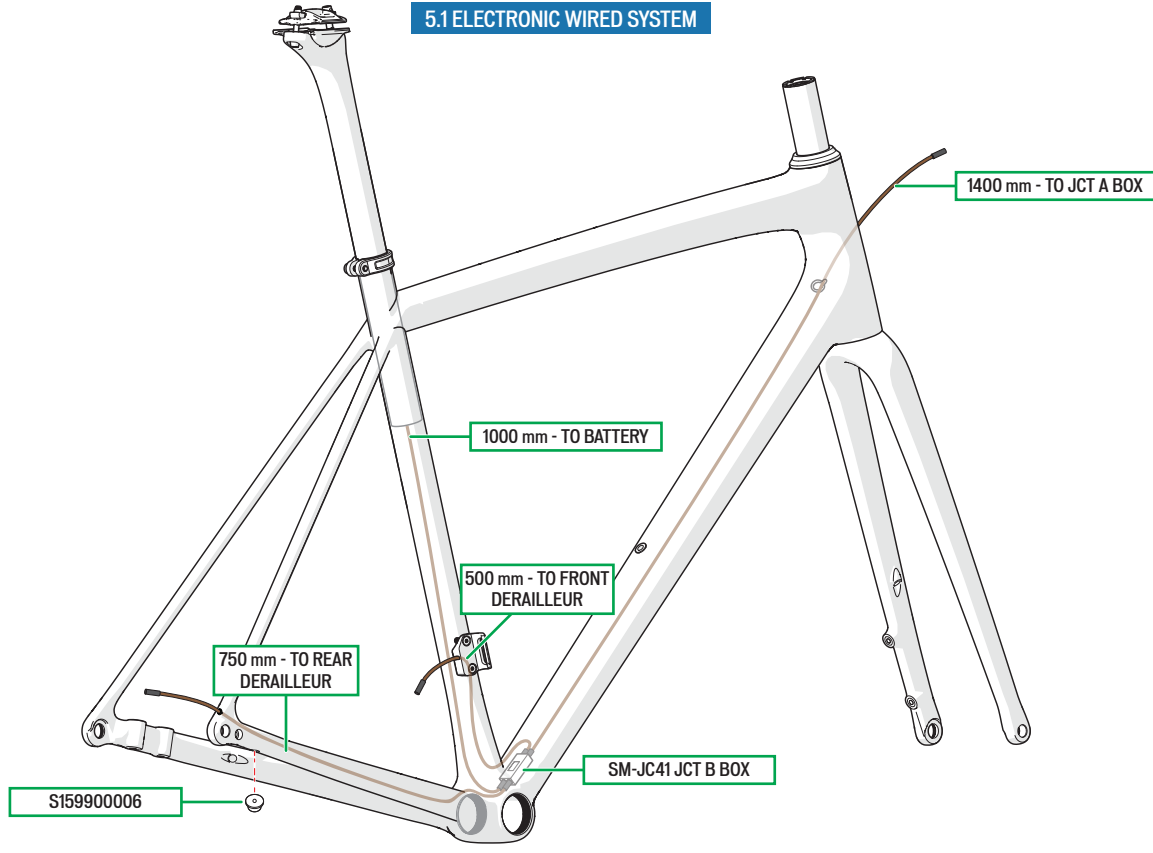

1

5.2 MECHANICAL SYSTEM, FULL LENGTH HOUSING  
(REAR DERAILLEUR AND DROPPER POST ONLY)

HOUSINGS CROSS ONLY IF RUNNING  
A DROPPER SEATPOST

S216500009

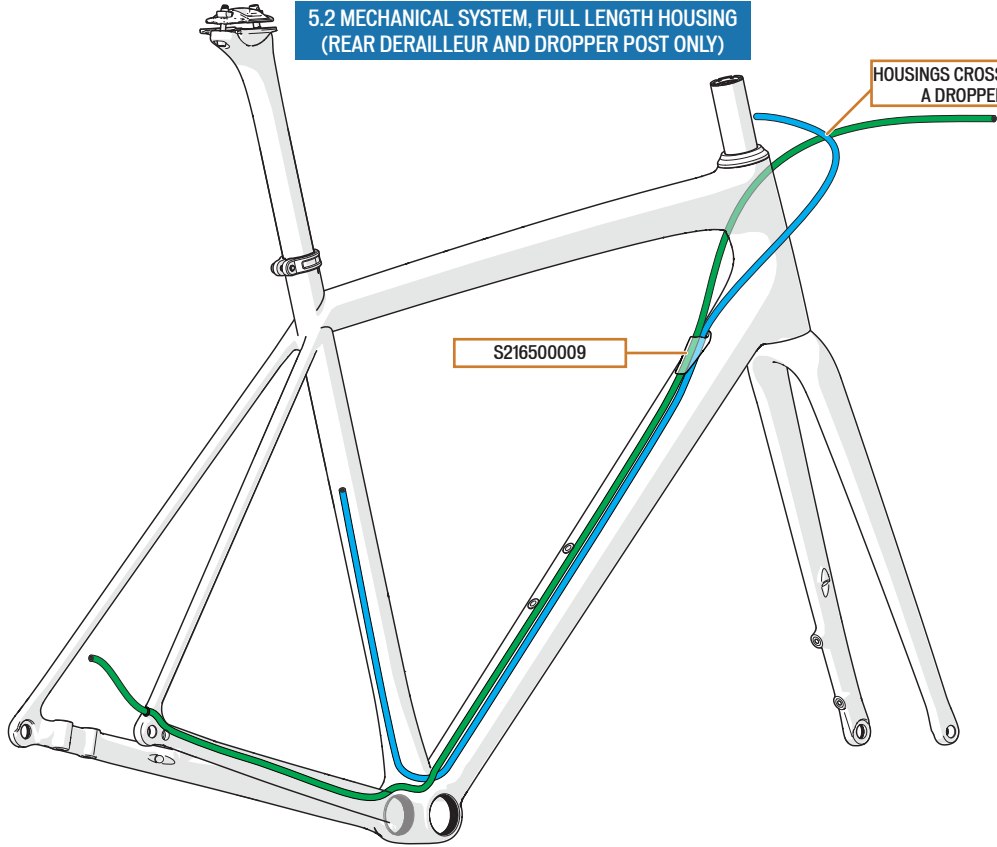

## 5.2. SHIFTING - MECHANICAL SYSTEM (REAR DERAILLEUR ONLY)

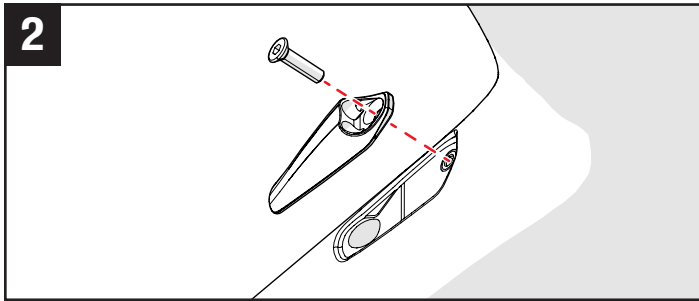

FIG. 2

- Install the down tube cable guide in the down tube ICR port.

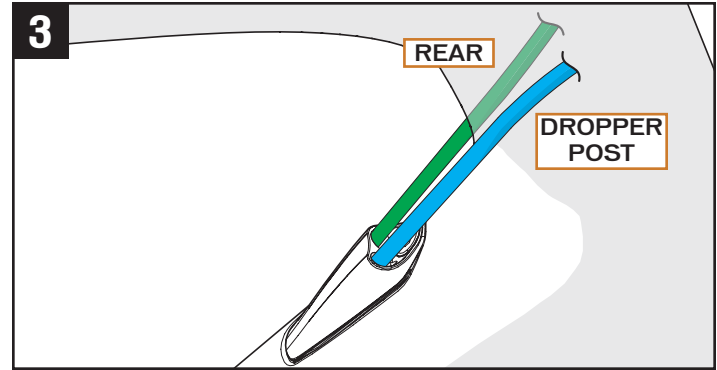

FIG. 3

- Install full-length housing to rear derailleur. Internal routing kit and magnets are helpful.



Use a similar procedure for the cable-actuated dropper seatpost.

1

5.4 DISC BRAKES

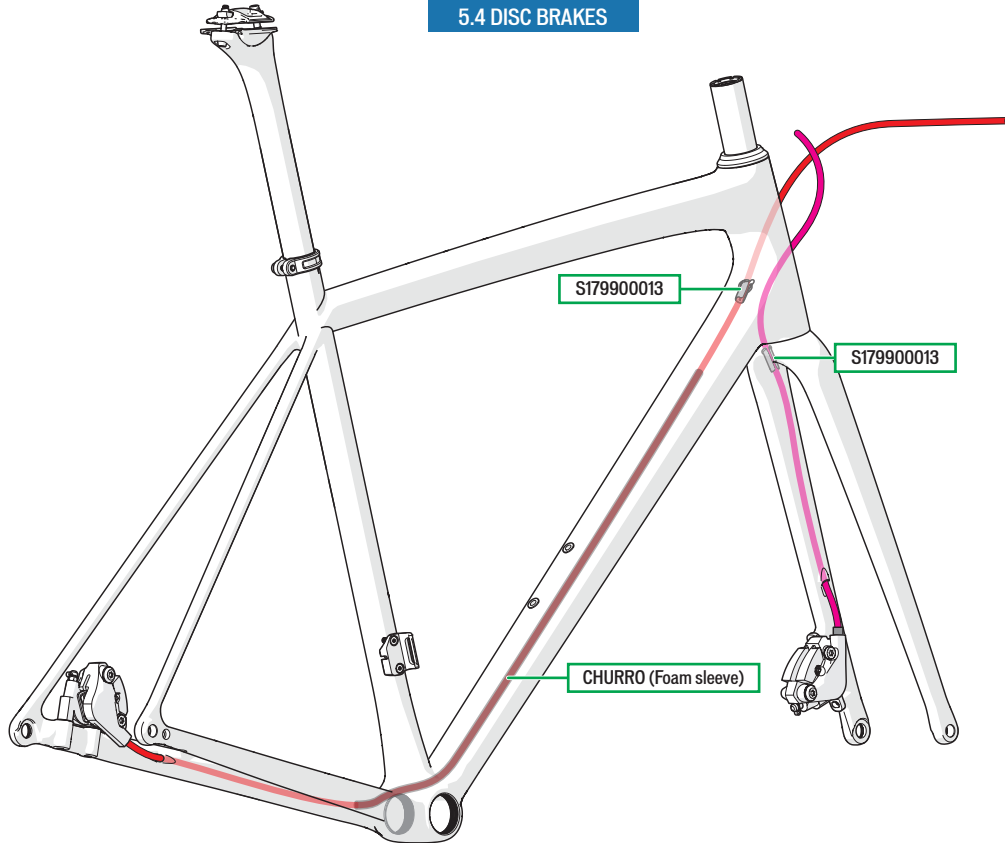

## 5.3. DISC BRAKES

FIG. 1

### ROUTE THE REAR BRAKE HOUSING:

- Run the rear brake housing in through the chainstay ICR port, over the bottom bracket shell, up the down tube.
- Install a churro (foam sleeve) over the brake housing and into the down tube.
- Route the brake housing out the head tube ICR port.
- Install a grommet over the brake housing and into the head tube ICR port.
- Install the caliper on the chainstay.
- Complete the rear brake installation according to the brake manufacturer's instructions.

### ROUTE THE FRONT BRAKE HOUSING:

- Run the front brake housing in through the lower ICR port in the fork and guide it up the fork leg until it exits at the ICR port on the fork crown.
- Install a grommet over the brake housing and into the upper fork ICR port.
- Complete the front brake installation according to the brake manufacturer's instructions.

## 6. SEATPOST ASSEMBLY



INFO: Most CruX models come with the Terra seatpost (1b).

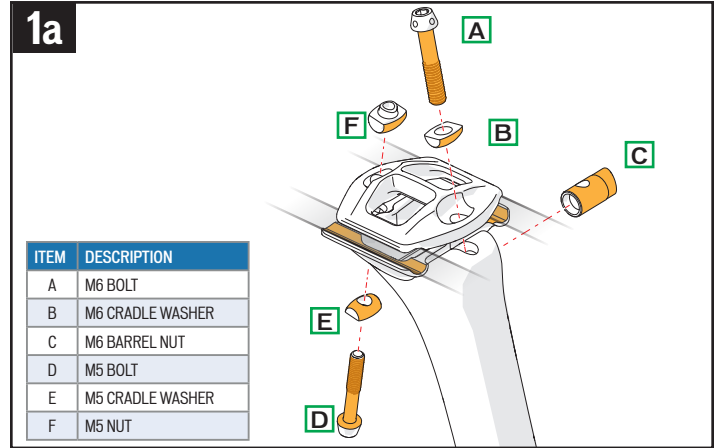
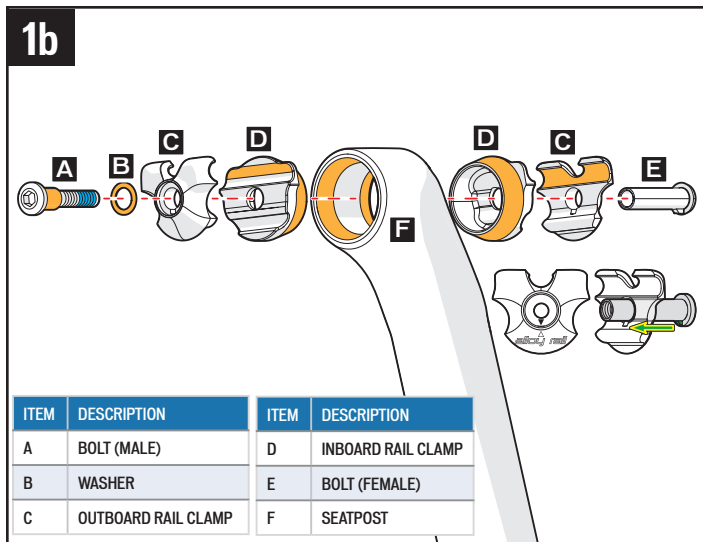

FIG. 1a - ALPINIST SEATPOST

- Grease then install the M6 barrel nut (C) inside the seatpost.
- Grease and assemble the M6 bolt (A) and M6 cradle washer (B), then install them in the upper cradle.
- Using a 5 mm Hex key, torque the M6 bolt (A) to 26.5 in-lbf / 3 Nm.
- Install the lower cradle, followed by the saddle (with greased rails) and upper cradle assembly.
- Grease and assemble the M5 bolt (D) and M5 cradle washer (E), then install the bolt and spacer through the seatpost bolt hole and through the lower cradle.
- Grease then install the M5 nut (F) onto the M5 bolt (D).
- Adjust the saddle fore-aft position, then adjust the angle of the saddle by turning the M6 bolt (A).
- With a 4 mm Hex key, torque the M5 bolt (D) to 55 in-lbf / 6.2 Nm, then check the saddle angle. If the angle still needs to be adjusted, loosen the M5 bolt (D), loosen or tighten the M6 bolt (A) accordingly, then torque the M5 bolt again. Repeat until the saddle is at the desired angle.



**FIG. 1b - TERRA SEATPOST**

- Grease the inboard rail clamp contact surfaces (D), then install them in the seatpost head assembly (F).
- Position the saddle rails on the inboard rail clamps.
- Position the outboard rail clamps (C) over the saddle rails. Use 7x7 mm clamps for alloy rails or 7x9 mm clamps for carbon rails.
- Insert the female bolt (E) through one of the outboard rail clamps and key the bolt tab in the outboard rail clamp groove.
- Apply threadlocker to the bolt threads (A) and grease to the bolt head and washer (B), then place the washer on the male bolt.
- Install the male bolt in the opposing outboard rail clamp, then thread it into the female bolt.

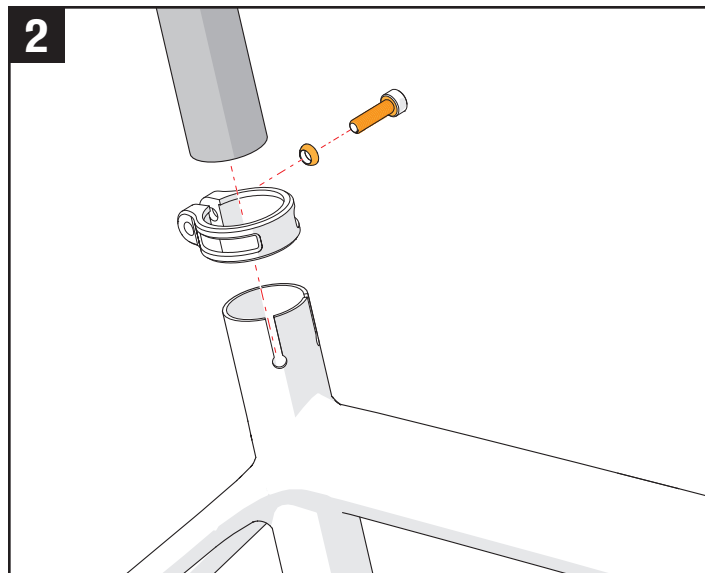

**FIG. 2**

- Make sure the seat collar bolt is facing toward the back of the bike.
- If using Shimano Di2, install the battery in the seatpost using the grommet assembly (S186800006), then plug the seat tube wire into the battery.
- Apply carbon assembly compound (fiber paste), then insert the seatpost into the seat tube.
- Grease the seat collar bolt and spacer, then use a 4 mm Hex key to torque the bolt to 55 in-lbf / 6.2 Nm.



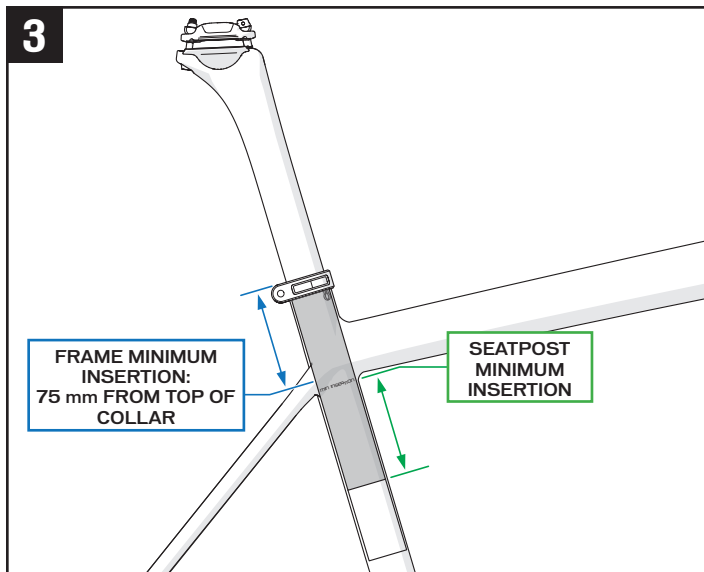

Fig. 3

Both the frame and seatpost have minimum insertion requirements. Additionally, the frame has a maximum insertion limit to prevent damage to the tire cutout area.

- **MINIMUM INSERTION:** The seatpost must be inserted into the frame deep enough so the minimum insertion/maximum extension (min/max) mark on the seatpost is not visible. The frame requires a minimum of 75 mm of insertion.
- If the post is at the minimum and the saddle is not at the desired position, the seatpost must be replaced with a longer or shorter seatpost.
- Once the saddle height is determined, torque the seat collar bolt (as seen in fig. 2) to 55 in-lbf / 6.2 Nm.



**WARNING!** Do not apply grease to the contact surfaces between the seatpost and the seat tube. Grease reduces the friction, which is critical to proper seatpost grip. Specialized recommends the application of carbon assembly compound (fiber paste), which can increase friction between carbon surfaces. Please visit your Specialized Authorized Retailer for additional information.



**WARNING!** Failure to follow the seatpost and frame insertion requirements (fig. 3) may result in damage to the frame and/or seatpost, which could cause you to lose control and fall.



**WARNING!** For general instructions regarding the installation of the seatpost, refer to the appropriate section in the Owner's Manual. Riding with an improperly tightened seatpost can allow the saddle and seatpost to slide down, which can damage the frame and cause you to lose control and fall.

## 7. FORK / STEM ASSEMBLY

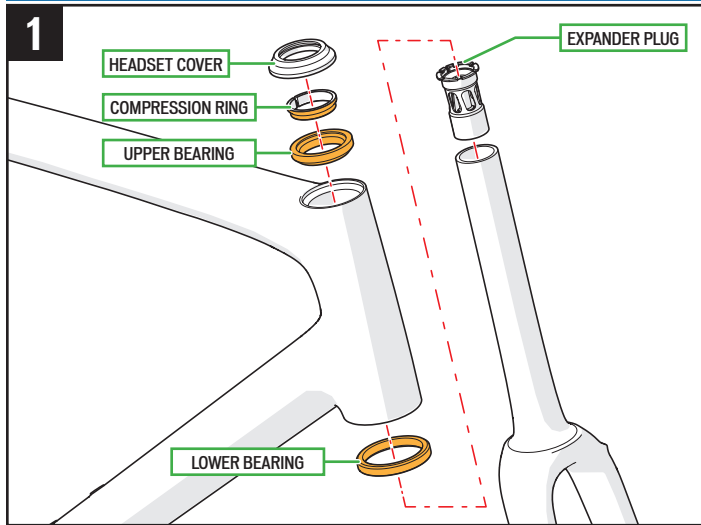

FIG. 1

- Install the front end (fork, headset, headset spacers, stem, handlebar, wheels) on the frame then determine the rider's fit. Do not install more than 35 mm of spacers between the stem and the headset cover (fig. 2).
- Trim the steerer tube so the final cut is 3 mm below the top of the stem (or 3 mm below the top of the spacer if a 5 mm spacer is used).
- Install the steerer tube expander plug. Using a 6 mm Hex key, torque the plug to 45 in-lbf / 5.1 Nm.
- When installing the headset for the final assembly, grease the bearings and compression ring.

- Install the headset cover, spacers and stem, followed by the top cap and bolt. Using a 4 mm Hex key, torque the bolt to 44 in-lbf / 5.0 Nm.
- Once the bike is fully assembled, adjust the headset, using the front brake to determine if there's any headset looseness.



Make sure to determine the appropriate rider stem height before cutting the steerer tube. Ideally, the steerer tube should be cut 3 mm below the top of the stem. Alternatively, one optional 5mm solid spacer may be placed above the stem (fig. 2). In that case, the steerer tube should be cut 3 mm below the 5 mm solid spacer.



**WARNING!** The stem must be fully supported by the expander plug. Do not place more than one 5mm solid spacer above the stem. In addition, the combined height between the stem and optional 5mm spacer (from bottom of stem to top cap) must not exceed 45mm. This is important if the originally equipped stem is changed with an aftermarket one. Exceeding 45mm or placing more than one 5mm solid spacer above the stem may cause the stem to crush the steerer tube which may result in serious injury or death.



**WARNING!** The CruX comes with one 5 mm solid spacer and 35 mm of scalloped spacers. Only the solid spacer should be used above the stem. The scalloped spacers should only be used below the stem, i.e. between the stem and the headset cover.



**WARNING!** Do not apply grease or carbon assembly compound (carbon paste) between the stem and the steerer tube, and do not twist the stem onto the steerer tube. This can result in damage to the composite surface, which may result in a catastrophic failure of the fork, resulting in serious personal injury or death.

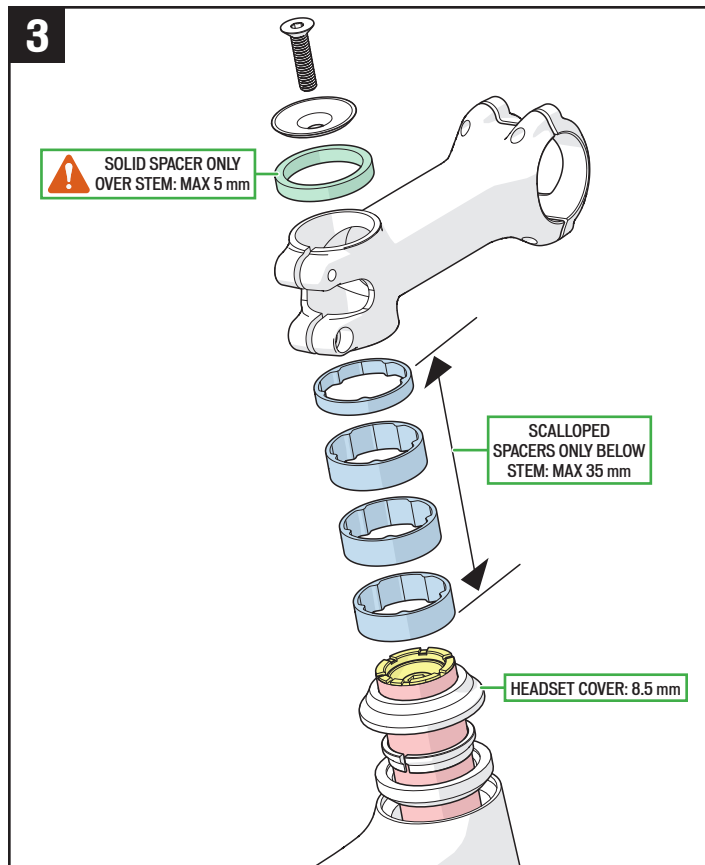
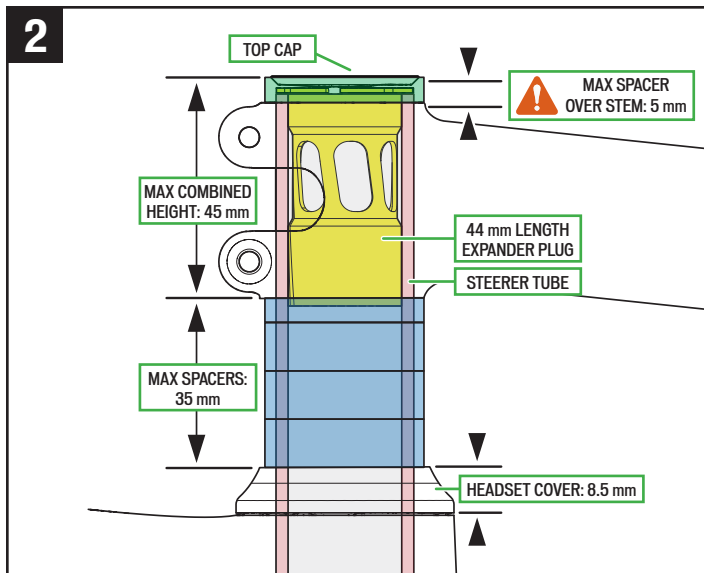

**FIG. 2 & 3**

- The headset cover measures 8.5 mm thick. The maximum spacer stack height between the headset cover and the stem is 35 mm, for a total of 42 mm.
- The maximum combined height of the stem's steerer tube clamp and any spacers placed above the stem (max 5 mm) must not exceed 45 mm.

**SPECIALIZED BICYCLE COMPONENTS**

15130 Concord Circle, Morgan Hill, CA 95037 (408) 779-6229